

5. Close the cover.

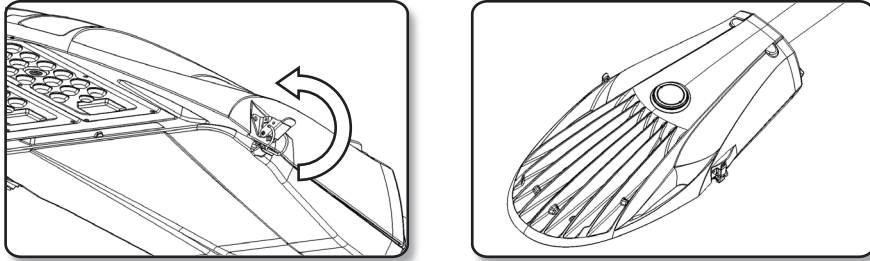

6. Make sure the luminaire is installed properly and the clips on two sides are well locked.

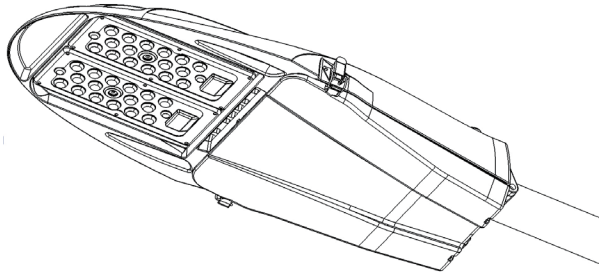

7. Power on for test.

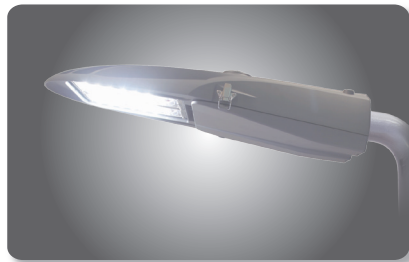

SL3-M LED Street Light

Installation Guide

Procedures of Installation

Please confirm your local voltage and related electronic specifications are matching the device before installation. Applicable diameter of pole for SL3-M is 1.6" to 2.6" (1.4" optional).

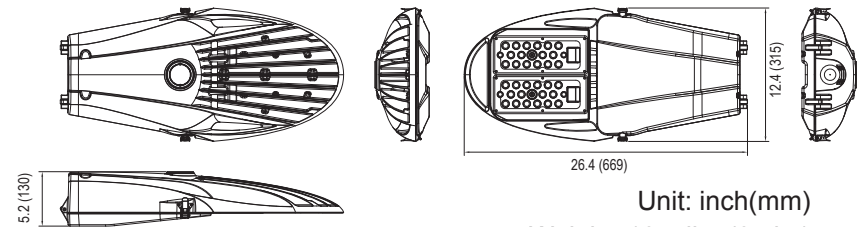

Unit: inch(mm)
Weight: 18.7 lbs (8.5kg)
Dimensions: 26.4" x 12.4" x 5.2"

The dimensions of SL3-M LED street light series.

1. Release two clips of the cover and open the cover.

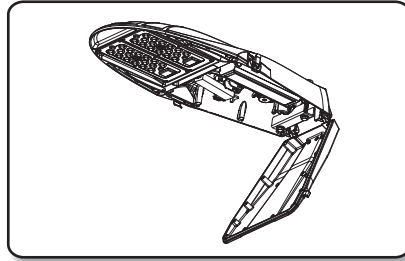
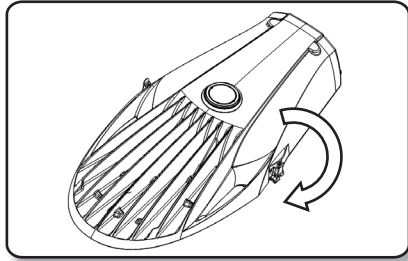

2. Install the luminaire to the pole.

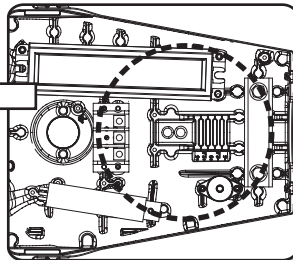
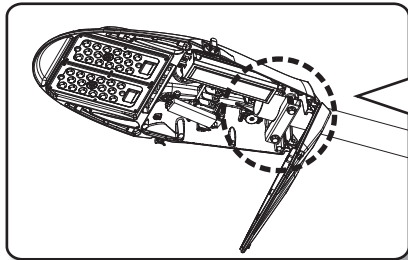

* 5-steps mounting allows a $\pm 5^\circ$ vertical tilt adjustable arm holder with an increment of 2.5° each step.

3. Screw the luminaire tightly.

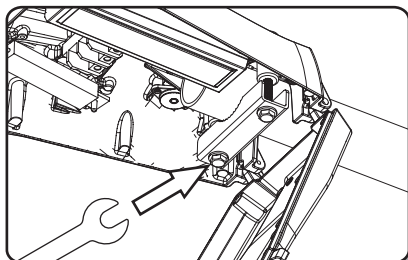

4. Please read the wiring diagram below first and connect the power cables to the right position. Be sure to screw tightly to avoid disconnection.

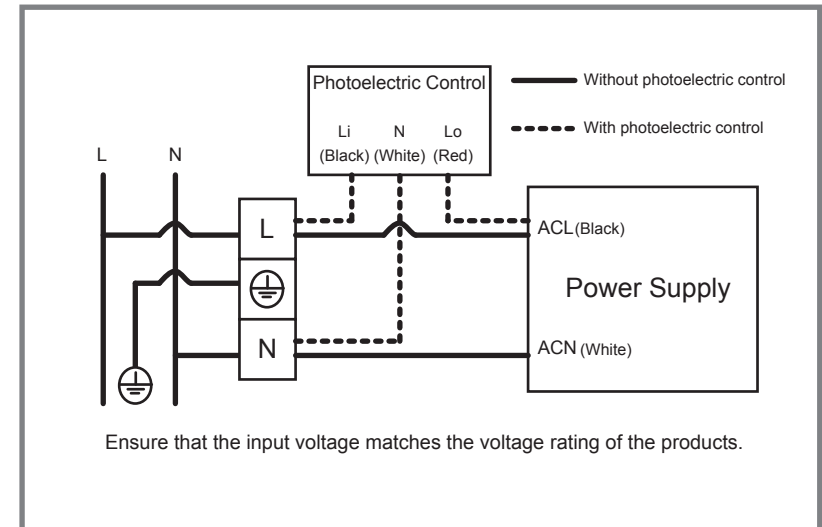
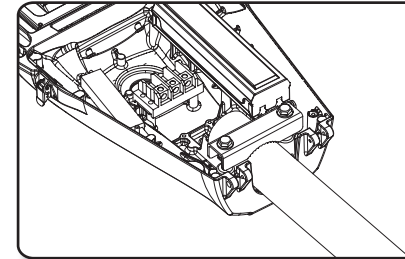

Wiring diagram