

5. Close the cover and secure both clips to lock.

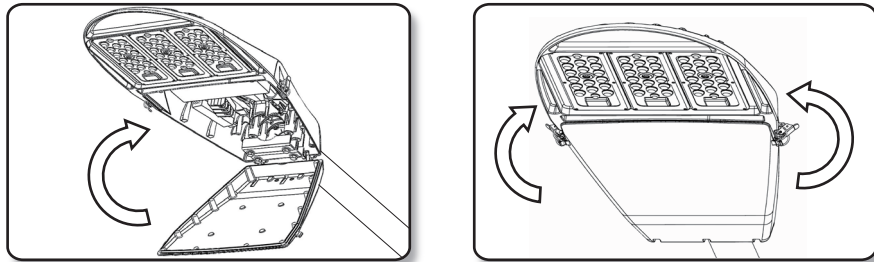

6. Make sure the luminaire is installed properly and clips on both sides are locked well.

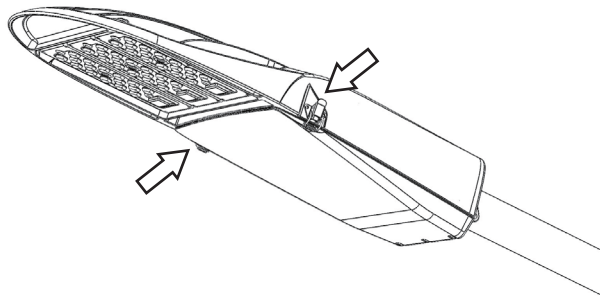

7. Power on for test.

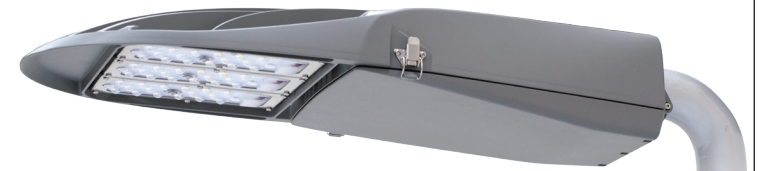
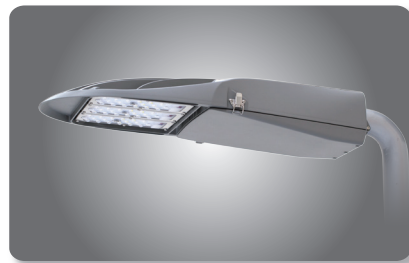

e-lite star™
an eoi brand - energy saving since 1995

SL3-L LED Street Light

Installation Guide

Procedures of Installation

Please confirm your local voltage and related electronic specifications are matching the device before installation. Applicable diameter of pole for SL3-L is 1.6" to 2.6" (1.4" optional).

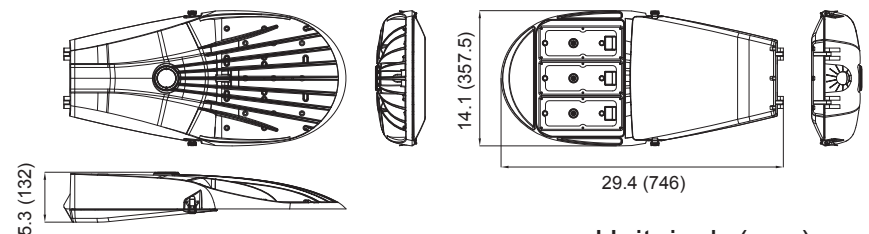

Unit: inch (mm)
Weight: 25.4 lbs (11.5 kg)
Dimensions: 29.4" x 14.1" x 5.3"

1. Release two clips on both sides of the luminaire to open the cover.

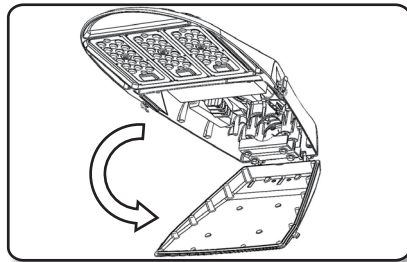
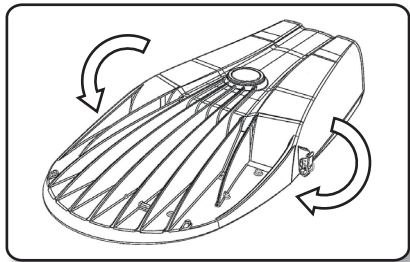

2. Install the luminaire to the pole and adjust to the desired position and angle.

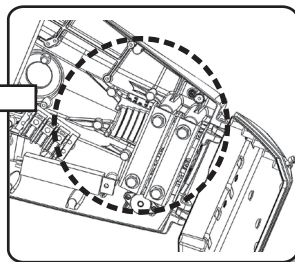
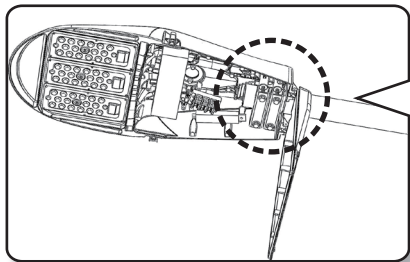

* 5-steps mounting allows a $\pm 5^\circ$ vertical tilt adjustable arm holder with an increment of 2.5° each step.

3. Screw the bolts of the luminaire tightly.

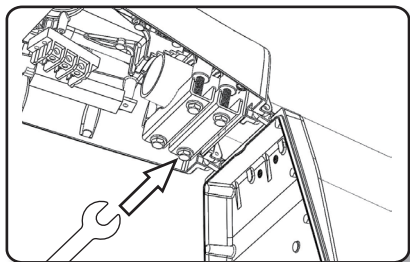

4. Please read the wiring diagram below first and connect the power cables to the right position. Be sure to screw tightly to avoid disconnection.

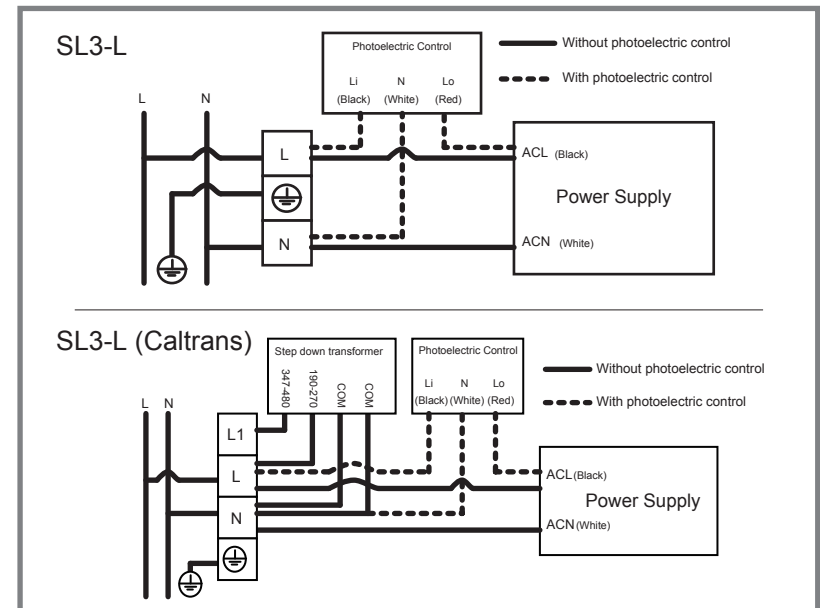
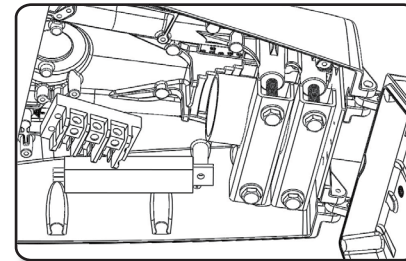

Wiring diagram